



# PowerXtreme

*Proud experts in LiFePO4 batteries!*

## User Guide

### **PowerXtreme X210** **LiFePO4 Battery 12,8V 210Ah**



PowerXtreme

# Table of contents

---

<b>PREFACE</b>	<b>4</b>
<b>1 INTRODUCTION</b>	<b>5</b>
1.1 Intended use	5
<b>2 PRODUCT DESCRIPTION</b>	<b>5</b>
2.1 Main components	5
2.2 Key specifications	6
2.3 Dimensions	7
<b>3 SAFETY</b>	<b>8</b>
3.1 Safety features	8
3.2 Safety symbols on the battery	8
3.3 Safety instructions	8
<b>4 STORAGE AND TRANSPORT</b>	<b>11</b>
4.1 Storage	11
4.2 Transport	11
<b>5 INSTALLATION</b>	<b>12</b>
5.1 General	12
5.2 Installation location	12
5.3 Contents of the package	12
5.4 Fixing	13
5.5 Parallel connection	13
<b>6 USE</b>	<b>14</b>
6.1 Charging the battery	14
6.2 Explanation of the charging indicator	15
6.3 PowerXtreme Pro App	16
6.3.1 Status	17
	17

6.3.2	Settings	18
6.3.3	Storage	18
<b>7</b>	<b>MAINTENANCE, INSPECTION AND CLEANING</b>	<b>19</b>
7.1	Maintenance	19
7.2	Inspection	19
7.3	Cleaning	19
<b>8</b>	<b>MALFUNCTION</b>	<b>20</b>
8.1	Replacing the fuse	21
<b>9</b>	<b>WARRANTY AND LIABILITY</b>	<b>22</b>
9.1	Warranty period	22
9.2	Exclusions	22
9.3	Invoking the warranty	23
<b>10</b>	<b>DEPOSIT</b>	<b>24</b>
<b>11</b>	<b>EU DECLARATION OF CONFORMITY</b>	<b>25</b>

# Preface

Read and understand this manual completely before installing, using, or servicing the battery pack. Use other than as described in this manual may cause a dangerous condition and will void the warranty.

Keep this manual near the battery pack for future reference.

## Target Group

This manual is intended for the persons who install and use the battery pack.

Any use other than as described in this manual will void the warranty.



## Relevant documentation

The following documentation is available for the battery pack:

Document	Location
User Guide	This document
E04-X210-ENxx_MSDS Material Safety Data Sheet	See our website

## Used symbols

Safety information is indicated by different levels of risk. Refer to the table for the meaning of the safety symbols in this manual:

Symbol	Meaning
 <b>DANGER</b>	Indicates a situation that, if safety instructions are not followed, <u>will</u> result in serious injury or death
 <b>WARNING</b>	Indicates a situation that, if safety instructions are not followed, <u>could</u> result in serious injury or death
 <b>CAUTION</b>	Indicates a situation that, if safety instructions are not followed, <u>could</u> result in minor or moderate injury
<b>NOTE</b>	Indicates a situation that, if safety instructions are not followed, <u>could</u> result in battery damage

Other symbols in this manual are not related to safety. See the table for the meaning of the other symbols in this manual:

Symbol	Meaning
 <b>Tip!</b>	Information useful to some readers

# 1 Introduction

## 1.1 Intended use

This battery is intended as a power source for a 12 VDC system. A maximum of 4 batteries may be connected in parallel.

This battery is not intended as a starter battery.

Any use of the battery other than as described in this manual is considered unintended use and voids the warranty.

## 2 Product description

The PowerXtreme X210 is a Lithium iron phosphate battery, also called LiFePO4 or LFP. The battery is very suitable for installation in, for example, a driving or marine vehicle, but can also be used unassembled. The battery can be easily installed and is protected against overload, overvoltage, undervoltage, temperature, and short circuit by the integrated battery management system.

### 2.1 Main components

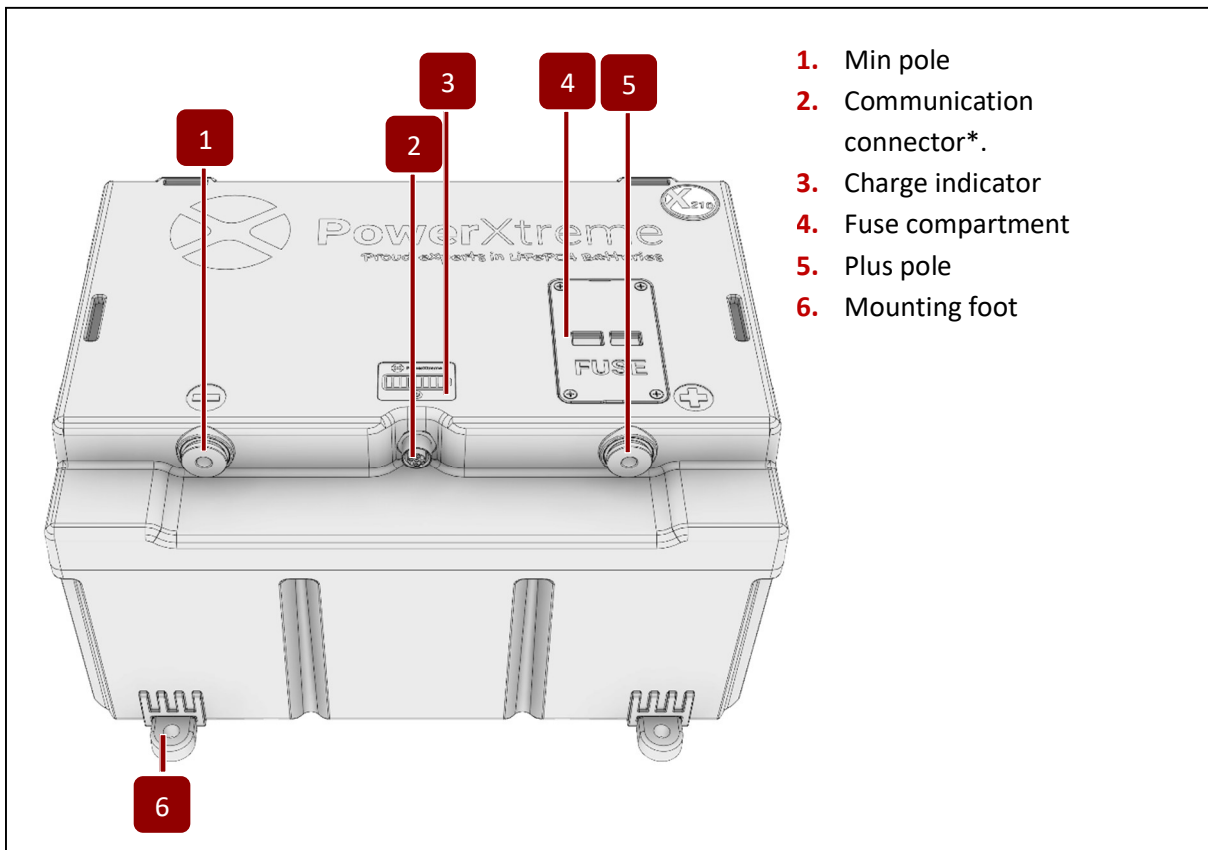

\* The communication connector is used only for specialized or professional applications. Always contact your supplier before using the communication connector.

## 2.2 Key specifications

### General

Model	X210
Article number	EM010210EN
Cell chemistry	LiFePO4 (Lithium Iron Phosphate)
Lifespan	Minimum 3000 charge cycles (at 80% DoD)
Dimensions	330 × 230 × 170 mm
Weight	18,9 kg
Connection	Poles with M8 female thread
IP class	IP65

### Input (charging)

Charging voltage	14,4 - 14,6 V
Max. charging current	150 A
Charge temperature	0 – 45 °C
Charging method	CC-CV

### Output (discharging)

Nominal voltage	12,8 V
End of discharge voltage	10,5 V
Capacity	210 Ah/ 2688 W
Nominal continuous current	250 A/ 3200 W
Short-term current (max. 30 sec)	< 400 A
Peak current (max. 1 sec)	< 750 A
Operating temperature	-20 – 60 °C

### Safety and certification

Internal security	Overcurrent
	Overvoltage and undervoltage
	Short circuit
	Protected against over- and under-temperature
Internal fuse	500 A
Certification	UN38.3/ MSDS/ CE

## 2.3 Dimensions

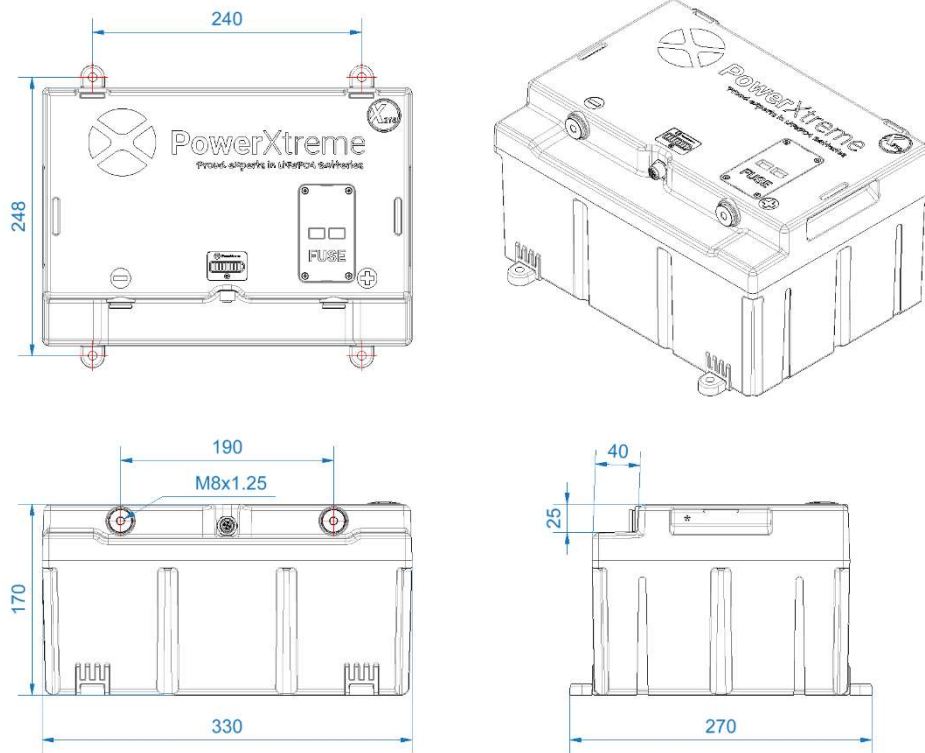

\* The mounting feet are removable.

## 3 Safety

### 3.1 Safety features

The following safety features have been incorporated into the design of the battery:

- The **integrated battery management system (BMS)** protects the battery against overload, overvoltage, undervoltage and short circuit. In addition, the battery is automatically switched off if the temperature falls outside the working temperature.
- The **internal fuse (500 A)** is an additional safety feature that protects the battery if the battery management system fails. In general, the BMS will intervene before the internal fuse is required.

### 3.2 Safety symbols on the battery

The following safety symbols are visible on the battery:

Symbol	Meaning
	Do not use near an open flame

### 3.3 Safety instructions

#### **DANGER**

Explosion danger! When connecting or disconnecting the battery, sparks can be produced that ignite flammable substances.

Never use the battery in the presence of flammable gases or substances.

#### **WARNING**

High currents can flow through the battery, with the risk of an electric shock:

- Pay attention to the polarity when connecting the contacts. Never connect the contacts to the wrong pole.
- Never touch both poles of the battery at the same time.
- Prevent unwanted contact between conductive objects and the poles.
- Do not immerse the battery in water or any other liquid.
- Keep the battery away from children and animals.
- If you install the battery in parallel, only combine batteries of the same type, age and capacity.



**⚠ WARNING**

Fire hazard! If the contacts are not properly secured to the terminals, this may cause arcing or the poles may become very hot. Always secure the contacts to the poles. We recommend using a torque wrench (M8, 16 Nm).

**⚠ WARNING**

The electrolyte in the cells is highly corrosive. A leaking battery can cause injuries and is harmful to the environment:

- Avoid damage to the battery casing.
- Do not expose the battery to aggressive chemicals.
- Do not use the battery if it is damaged or defective.
- Do not disassemble or shred the battery in any way when discarding it.
- Do not expose the battery to temperatures higher than 65 °C or fire.
- Never touch the electrolyte.
- If you do come into contact with the electrolyte, rinse it with plenty of water and contact a doctor

**⚠ WARNING**

Risk of injury! The battery is heavy and can become a projectile in the event of a crash if it is not properly secured. During transport, always ensure that the battery cannot move.

**⚠ WARNING**

Never install the battery in series with other batteries.

**NOTE**

Risk of damage to the battery. Salt water causes corrosion on the poles:

- Do not expose the battery to salt water

**NOTE**

Risk of damage to the battery. If used incorrectly, high currents can flow through the battery:

- Do not use the battery as a starter battery.
- Never connect the battery in parallel with another type of battery, such as directly to the wiring from a vehicle. Always use a charging system for this.

## **NOTE**

Risk of damage due to overheating:

- Keep the battery away from dust and dirt and place it in a well-ventilated area. Never cover the battery with clothing or other materials.

## **NOTE**

Incorrect use shortens the life of the battery:

- Do not leave the battery on the charger for a long time, when storing it, if the battery is already full.
- If the battery is discharged for a long time, the battery may be irreparably damaged. Charge the battery to at least 80% at least once a year.

## **NOTE**

Some regulations may restrict the transportation of this battery:

- Always check local regulations.
- Check any additional regulations if you want to transport a damaged battery.

## **NOTE**

Risk of short circuit. If you connect the battery directly to a starter battery and alternator, very high currents can flow through the battery. Always use a charging booster if you want to charge the battery via the starter battery and alternator.

## 4 Storage and transport

### 4.1 Storage

Do not remove the battery from the original packaging until you need it. To store the battery for a longer period of time, if you have already used the battery, proceed as follows:

1. Charge the battery to at least 80% (see chapter 6.1).
2. Disconnect the battery from all charges and, if present, the charger.
3. Place the battery in storage mode (see chapter 6.3.1).
4. Store the battery in a location that is:
  - Clean and dry;
  - Temperature between -10 – 45 °C.
  - Humidity < 80% (non-condensing).

**i Tip!** If the battery is installed in a vehicle or vessel, the battery can remain installed in the vehicle or vessel, even during long-term storage. Make sure that one pole is disconnected or that the battery does not receive charging voltage from, for example, a solar panel. A charging voltage takes the battery out of storage mode.

5. If possible, store the battery in its original packaging.
6. Charge the battery annually to at least 80% to keep the battery in optimal condition.

#### **NOTE**

Risk of damage to the battery. If the battery is discharged for a long time, the battery may be irreparably damaged. Charge the battery annually to at least 80%.

#### **NOTE**

Self-discharge per month is < 2%

### 4.2 Transport

#### **⚠ WARNING**

Risk of a dangerous situation! The battery can become a projectile in the event of an accident if it is not properly secured. During transport, always ensure that the battery cannot move.

#### **NOTE**

Risk of legal violation. Some regulations may restrict the transportation of this battery:

- Always check local regulations.
- Check any additional regulations if you want to transport a damaged battery.

Transporting a lithium battery falls under hazard class UN3480, class 9, and packaging class P965, Chapter II.

If possible, transport the battery in its original packaging. Secure the battery securely.

# 5 Installation

## 5.1 General

The following is important for the installation:

### **⚠ WARNING**

Always use the correct cabling with sufficient cross-section and correctly sized cable lugs or battery terminals (to ensure that no heating or unnecessary losses occur). Always use the correct crimping tool to crimp the cable lugs and follow the instructions of the cable lug manufacturer.

### **NOTE**

Tighten all connections properly, the recommended tightening torque for the M8 bolt in the battery terminal is 16 Nm. Do not use a higher tightening torque, as this may cause irreparable damage to the battery.

### **NOTE**

The bolt length depends on the quantity and thickness of the cable lugs. To guarantee a good connection, the bolt must be turned at least 5mm into the pole. The bolt must not be screwed more than 10mm into the battery terminal connection. A bolt that is too long can cause irreparable damage.

### **NOTE**

We recommend using electrolytically galvanized (ELVZ) M8 bolts.

**i Tip!** Use a red cable for the plus (+) and a black cable for the minus (-).

## 5.2 Installation location

The installation location must meet the following conditions:

- Protected from weather conditions.
- Sufficient ventilation for the battery.

### **NOTE**

Do not install the battery with the poles facing down. Risk of battery malfunction.

## 5.3 Contents of the package

Check whether all parts are undamaged in the package. Please refer to the table below for this.

Quantity	Part
1×	Battery
4×	Mounting feet
1×	Interior sticker

Report missing or damaged parts to your supplier.

## 5.4 Fixing

### **⚠ WARNING**

Risk of a dangerous situation! The battery can become a projectile in the event of an accident if it is not properly secured. Always fix the battery when using it in a vehicle.

The battery can be used free-standing or fixed. If you do not want to fix the battery, you can skip this chapter.

The surface on which you want to fix the battery must meet the following requirements:

- Strong enough to support the battery.

Fix the battery as follows:

1. Place the mounting feet in the mounting foot holders.
2. Install the battery through the holes in the mounting base holders. Use a mounting method that is appropriate for the weight of the battery and the surface on which you are mounting the battery.

## 5.5 Parallel connection

To increase the capacity, up to a maximum of 4 batteries can be connected in parallel. The following image shows how to connect the batteries in parallel.

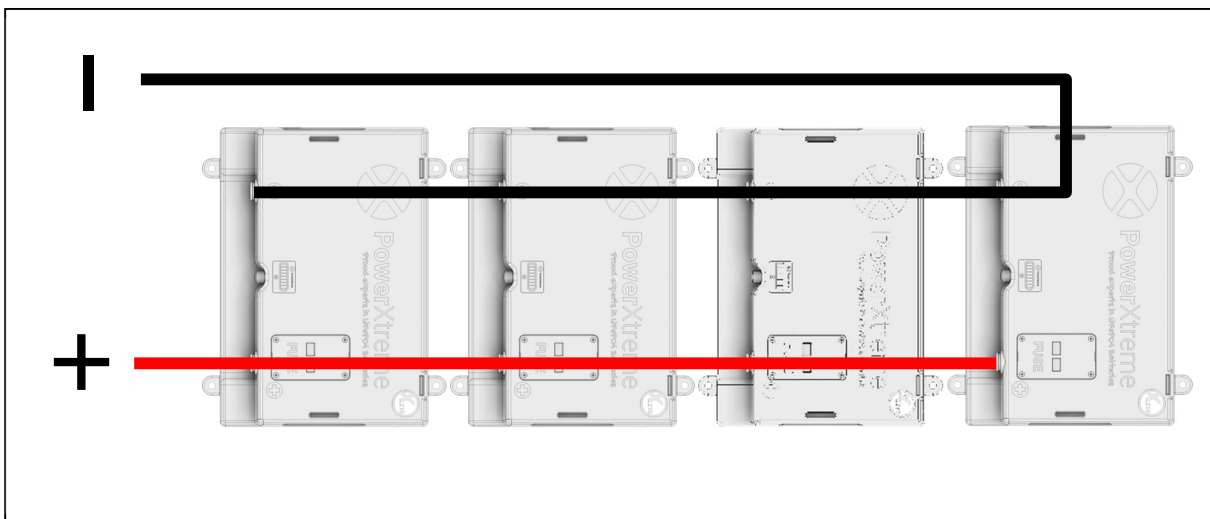

### **NOTE**

When connecting the batteries in parallel, an external fuse must always be installed.

### **NOTE**

When multiple batteries are used in parallel, the wiring must be sized and specified according to the maximum current that the parallel bank can supply.

## 6 Use

### **⚠ WARNING**

Risk of electric shock! A large current can flow through a battery:

- Never touch a terminal of a battery when the battery is connected.
- Never touch both poles of a battery at the same time

### **⚠ WARNING**

Risk of injury! Using a damaged battery is a danger to your health:

- Never use a damaged battery.
- Never touch liquid leaking from the battery.

Before using the battery for the first time, the battery must be fully charged to a voltage of 14.4 – 14.6 V. This is to check whether the installation is working properly.

### 6.1 Charging the battery

You need a battery charger to charge. The battery charger (booster and solar panels) must meet the following:

- Suitable for LiFePO4 lithium batteries.
  - Charging voltage from 14.4 to 14.6 V.
  - Equipped with a restart charging function.
  - CC-CV charging characteristic.
  - Stops charging when the battery is full.

### **NOTE**

Risk of irreparable damage to the battery. Never start charging if the battery temperature is below 0 °C. (The battery is protected against this and will therefore not start charging.)

### **NOTE**

Chance of large currents. If you connect the battery directly to a starter battery and alternator, very high currents can flow to and from the battery. Always use a charging booster if you want to charge the battery via the starter battery and alternator.

Charge the battery as follows:

1. Connect the positive connection of the battery charger to the positive terminal of the battery.
2. Connect the negative connection to the negative terminal of the battery.
3. Connect the battery charger to mains power by plugging it into a socket or connecting it to an integrated on-board system.

The battery can also be charged by solar panels. Follow the instructions in the User Guide of the solar panels.

**i Tip!** The XS20s MPPT solar charger with solar panels from our product range is a very suitable solar charger for this battery.

## 6.2 Explanation of the charging indicator

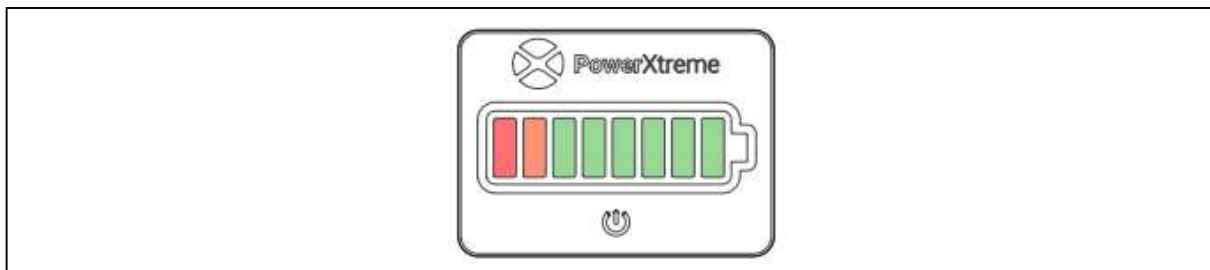

To use the charging indicator:

1. Press the charging indicator button to see the battery status.

The battery status can be read as follows:

- If the red LED flashes, the battery capacity is lower than 5%.
- If the battery is not connected to a charger, all LEDs up to the LED of the current charge level light up for 5 seconds.
- If the battery is connected to a charger, only the LED of the current charge level lights up for 5 seconds.

< 5 %	Current charge level	Current charge level (on charger)

## 6.3 PowerXtreme Pro App

You can read the status of your battery via your phone or tablet via the PowerXtreme Pro app.



[www.powerxtreme.eu/powerxtremeproapp](http://www.powerxtreme.eu/powerxtremeproapp)

To use the app:

1. Download the app from the App Store or Play Store on your device.
2. Turn on Bluetooth on your device.
3. On an Android device, turn on location services.
4. Open the app.
5. If necessary, allow the app to use Bluetooth.

The main screen of the app appears. The main screen lists all Bluetooth devices within 5 meters of your device.

6. Search the list for a name with the following format: "X210-\*\*\*\*\*".

**i** **Tip!** If you have changed the Bluetooth name yourself, the battery will appear in the list with this name. Use the Refresh button if your battery is not visible in the list.

7. Select your battery.



### 6.3.1 Status

The battery summary appears.

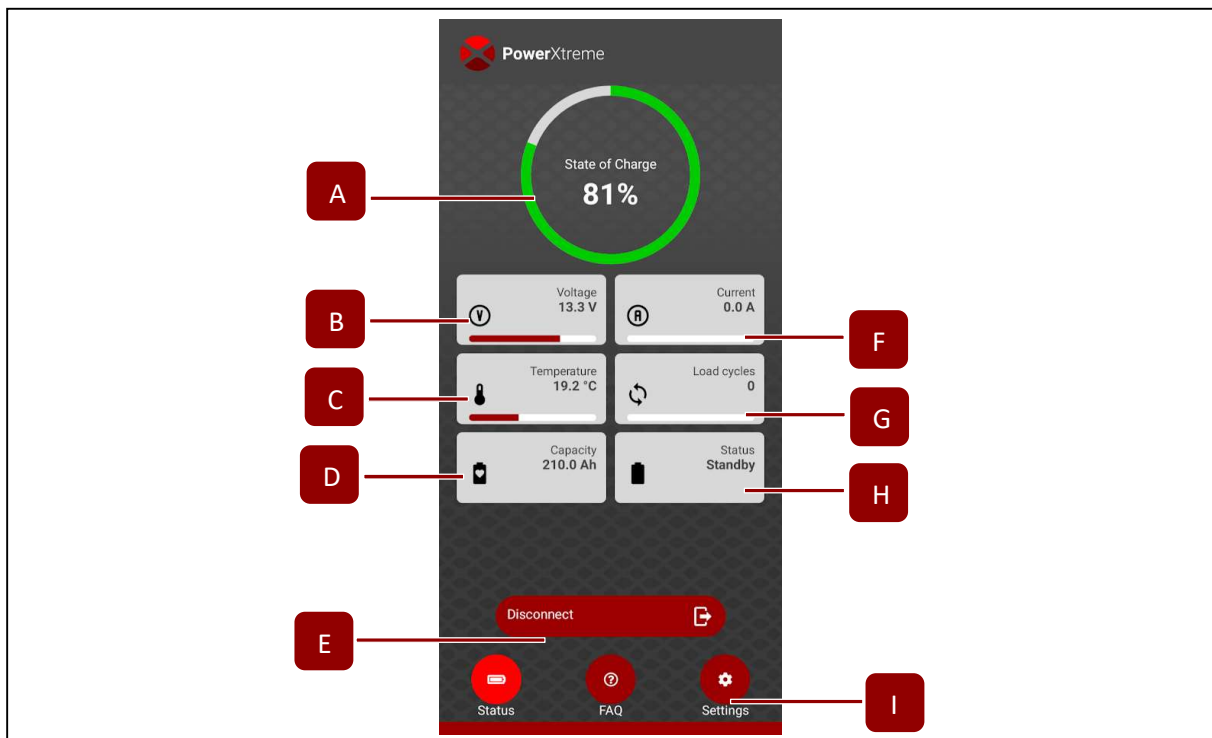

	Data	Meaning	
A	State of Charge	The current charge level of the battery	
B	Voltage	Battery voltage	
C	Temperature	Current temperature of the battery	
D	Capacity	Current capacity of the battery	
E	Disconnect	De knop om de bluetooth verbinding te verbreken tussen het apparaat en de accu	
F	Current	Current through the battery (red = discharging, green = charging)	
G	Load cycles	Number of charge/discharge cycles	
H	Status of the battery	Standby	Battery is ready to do work
		Charging	The battery is charging
		Discharging	Power is being drawn from the battery
		Save mode	The battery is in save mode
		Short circuit	A short circuit has occurred in the battery pack (section 8)
		Too cold to charge	Battery temperature is too low to start charging
I	Settings button	Settings of your battery (see chapter 6.3.2)	

### 6.3.2 Settings

Change the settings as follows:

- Press *Settings* in the battery overview.

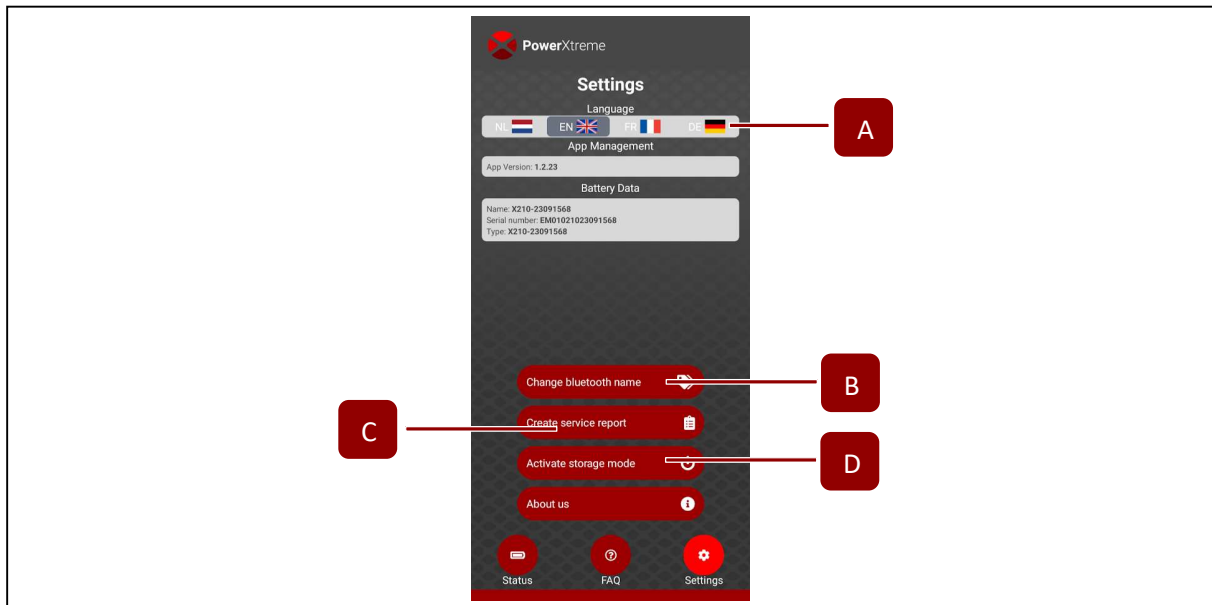

Data	Meaning
A Language	Change the language of the app
B Change bluetooth name	Change the name of the battery
C Create service report	If necessary, a service report can be created
D Activate storage mode	Turning save mode on or off

### 6.3.3 Storage

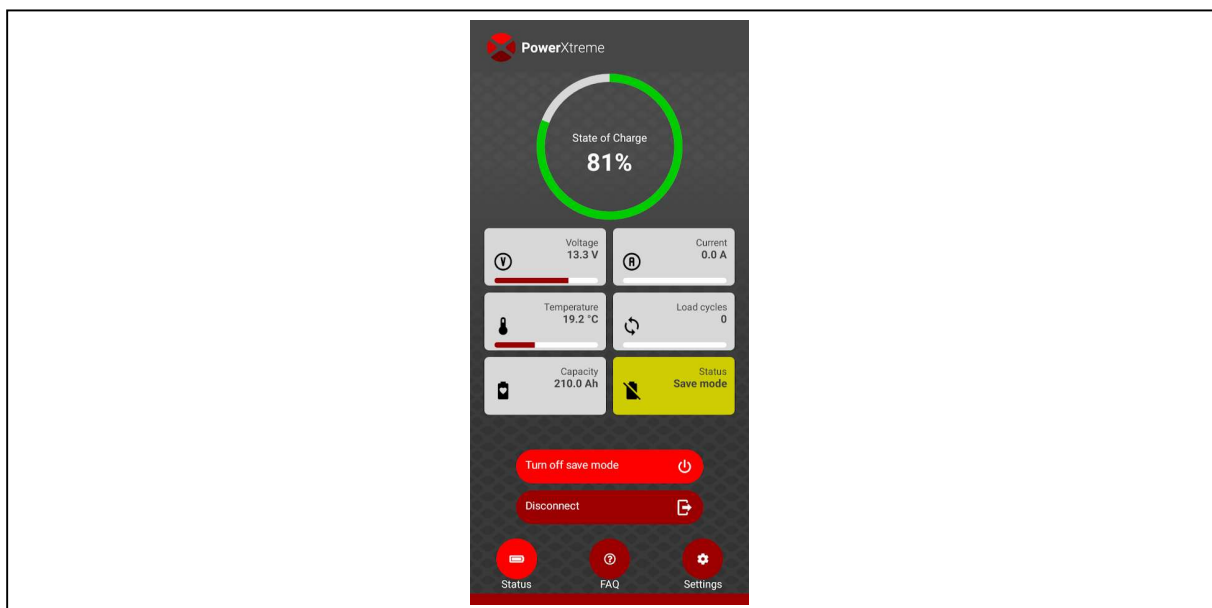

Data	Meaning
A Status	Status indicates that the battery is in save mode
B Turn of save mode	The battery can be removed from save mode

## 7 Maintenance, inspection and cleaning

### 7.1 Maintenance

The battery does not require any special maintenance, this battery is maintenance-free, but must be fully charged at least every year.

### 7.2 Inspection

Check the wiring and connections at least once a year. Correct defects such as loose connections, melted cable insulation or burnt cables immediately.

It is best to replace the battery with a new one if you notice the following:

- The capacity has decreased to such an extent that you are experiencing problems with it.
- The battery charging time becomes considerably long

#### **WARNING**

Never touch the fluid (electrolyte) from a damaged battery.

### 7.3 Cleaning

If necessary, clean the battery with a damp cloth.

#### **NOTE**

Do not contact the battery terminals. If necessary, disconnect the cables.

#### **NOTE**

Never use solvents or abrasives to clean the battery.

## 8 Malfunction

This table provides an overview of solutions for possible problems with the battery. If you cannot solve the problem using this manual, please contact your supplier.

<b>Problem</b>	<b>Possible problem</b>	<b>Possible solution</b>
The battery is not discharging	The battery is too discharged (< 5%)	Charge the battery (chapter 6.1)
	A short circuit has occurred.	Disconnect and reconnect connections except the loads or turn off the loads. Charge the battery briefly.
	The battery is overloaded	
	The battery temperature is lower than -20 °C or higher than 60 °C	Bring the battery to room temperature
	The battery is in storage mode	Remove the battery from storage mode (chapter 6.3.1)
The battery is not charging	The battery temperature is lower than 0 °C or higher than 45 °C	Bring the battery to room temperature
	The charger is not suitable for the battery	Check the specifications of the charger with the specifications in chapter 6.1
There is no voltage on the poles.	A short circuit has occurred.	Disconnect and reconnect the connections except the loads or switch off the loads. Charge the battery briefly.
	The battery is overloaded	
There is no voltage on the poles and the orange LED is flashing	The battery is in storage mode	Remove the battery from storage mode (chapter 6.3.1)
The charging indicator shows nothing when the button is pressed.	The battery is completely empty.	Charge the battery (chapter 6.1).
The charging indicator seems to give an incorrect indication.	The calibration of the charging indicator is no longer correct.	Charge the battery fully (chapter 6.1). When the battery is fully charged, press and hold the charge indicator button for ± 10 seconds until the lights flash.
The battery does not connect to the app	The battery is completely empty	Charge the battery (chapter 6.1).
	The battery is not within range of your device	Make sure the battery is within 5 meters of your device
	The Bluetooth of your device is turned off	Turn on Bluetooth on your device
The fuse has blown	A too high of a current has flowed through the battery	Contact your supplier

## 8.1 Replacing the fuse

If the fuse blows, the battery may be defective. Always contact your supplier if the fuse blows. Only replace the fuse if your supplier indicates so.

### **NOTE**

Risk of irreparable damage to the battery. Always replace the fuse with a fuse of the same brand and the same torque (500 A). Using any other type of fuse can irreparably damage the battery.

 **Tip!** Order a new fuse from your dealer with product code EP1200500.

Replace the fuse as follows:

1. Disconnect all connections to the battery.
2. Open the fuse compartment.
3. Remove the fuse from the fuse compartment.
4. Install a new fuse in the fuse compartment (Tightening torque: 16 Nm).
5. Close the fuse compartment.

## 9 Warranty and liability

EmergoPlus B.V. guarantees that the PowerXtreme X210 is built in accordance with the legally applicable standards and regulations. All batteries have been extensively tested and checked during production and before delivery. If you do not act in accordance with the instructions and provisions of this manual, damage may result and/or the unit may not meet our specifications. This may mean that the warranty will become void. The standard warranty period is 2 years. If you register your battery with us within 6 months of purchase (via website <https://emergoplus.com/register/>) we will extend the warranty period to 5 years.

### 9.1 Warranty period

EmergoPlus B.V. guarantees within the warranty period of 5 years (\*after registration) that the product is free from material and manufacturing defects under normal use, if installation and maintenance instructions have been followed and normal storage (storage means the condition in which the product is not used for its intended purpose). The warranty period starts on the date of purchase (invoice date). This warranty is not transferable upon resale..

### 9.2 Exclusions

This warranty does not apply to: (a) wear, corrosion, discoloration and aging resulting from normal use and storage; (b) damage as a result of incorrect and/or improper maintenance; (c) damage caused to the product by external causes such as fire, (immersion in) water, vapour, liquid, ice, incorrect application, falling, neglect, incorrect use (including use contrary to the requirements set by EmergoPlus B.V. given instructions) or misuse.

### 9.3 Invoking the warranty

If you wish to invoke this warranty, you must inform the point of sale where you purchased the product of the defect within a reasonable period after the defect has been discovered, but in any case before the end of the warranty period. You can also contact the head office of EmergoPlus B.V. When invoking the warranty, the product (or defective part) and the warranty certificate, obtained during registration, or the original purchase receipt must be presented. Registering for warranty must be done within six months of purchase.

- The warranty becomes void if the instructions stated in this manual are not followed or repairs are carried out without permission.
- The battery must not be opened. The warranty becomes void if the battery has been opened and the warranty seal has been broken.

EmergoPlus B.V. cannot be held liable for:

- Damage resulting from the use of the battery.
- Possible errors in the supplied manual and their consequences.
- Use incompatible with the purpose of the product.
- The information in this document is subject to change without notice. EmergoPlus BV is not liable for technical errors or omissions in this document. The purchased product may differ from the product described in this manual.

EmergoPlus B.V.'s liability is limited to the costs of repair and/or replacement of the product under warranty. The battery must be delivered to EmergoPlus B.V. In case of a product replacement, the warranty date starts at the time of purchase of the original product. EmergoPlus B.V. is not liable for loss of profit, consequential damage, indirect damage or other special forms of damage. In any event, this warranty does not affect your statutory rights as a consumer and is only valid and legally enforceable in the country where the product was purchased.

## 10 Deposit

### **WARNING**

Risk of injury. The battery contains substances that are harmful to human health. Do not disassemble or shred the battery in any way when discarding it.

### **WARNING**

Failure to follow the instructions in this manual could result in injury or damage to the product. Make sure that this manual, a copy or a reference thereto is included if you resell the battery.

If you have a defective battery, first contact your supplier. The battery may still be repairable.

 **Tip!** You can also return a broken battery to your supplier.

If you do have to dispose of the battery, do so as follows:

1. If the battery is not defective, discharge the battery as far as possible.
2. Insulate the terminals with electrical tape or other protection that covers the terminals.

### **NOTE**

This battery is a Lithium battery and can be harmful to the environment if improperly disposed of. Do not dispose of the battery with normal household waste.

3. Dispose of the battery in accordance with local and national laws and regulations.



# 11 EU Declaration of Conformity

## *EU DECLARATION OF CONFORMITY*



1. **Product model:**  
PowerXtreme X210
2. **Name and address of the manufacturer or his authorized representative:**  
EmergoPlus B.V.  
Informaticastraat 20  
4538 BT Terneuzen  
The Netherlands
3. **This declaration of conformity is issued under the sole responsibility of the manufacturer.**
4. **Object of the declaration**  
Description: Lithium ION LiFePO4 Battery  
Brand name: PowerXtreme  
Model/type: PowerXtreme X210  
Rating: 12.8V 210Ah 2688Wh
5. **The object of the declaration described in point 4 is in conformity with the relevant Union harmonization legislation:**  
EMC Directive 2014/30/EU  
Low Voltage Directive 2014/35/EU  
RED Directive 2014/53/EU
6. **References to the relevant harmonized standards used, or references to the specifications in relation to which conformity is declared:**  
EMC: IEC 61000-6-3:2021  
IEC 61000-6-2:2019  
LVD: IEC 62619:2022  
RED: EN 300 328  
EN 301 489-1  
EN 301 489-17  
IEC 62479:2010

**Signed for and on behalf of:**

Terneuzen, 01 February 2024

EmergoPlus B.V.

Dick van Wijck, CEO

A handwritten signature in black ink, appearing to read 'Dick van Wijck', is written over a horizontal line.

Document: E03-EM010210-EN00\_X210 EU Declaration of Conformity



**EmergoPlus B.V.**

Informaticastraat 20  
4538 BT Terneuzen,  
Nederland



[www.emergoplus.com](http://www.emergoplus.com)  
[info@emergoplus.com](mailto:info@emergoplus.com)

Original manual in English  
E09-X210-EN02\_Manual  
V2.0 – January 2024



**PowerXtreme**